

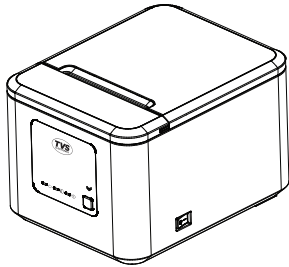

Quick Start Guide

RP 3230



Packing List

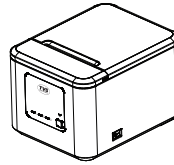

Printer

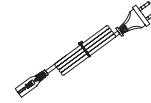

Power Cord



Quick Start Guide

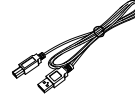

USB Cable

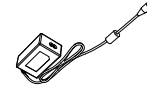

Power Adapter

⚠ Note:

- 1) Items in the package depend on the actual order.
- 2) Kindly visit <https://www.tvse.in/> for more details.

Appearance

■ Front & Side View

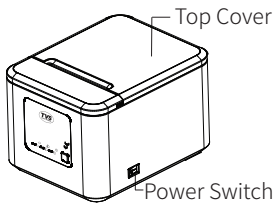

■ Back View

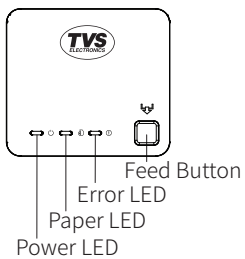
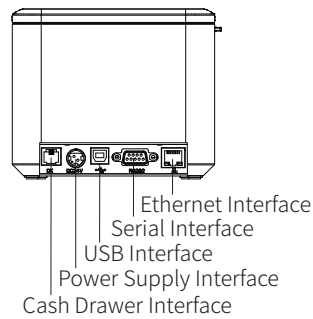

■ Bottom View

Holes for hanging on the wall

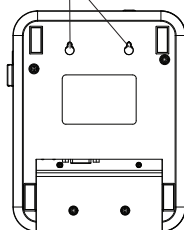

Cover Opening Button

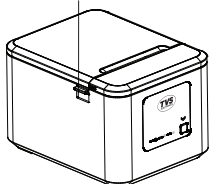

Paper Loading

1. Press the cover opening button to open the top cover.
2. Load the paper roll in the correct direction as shown below.

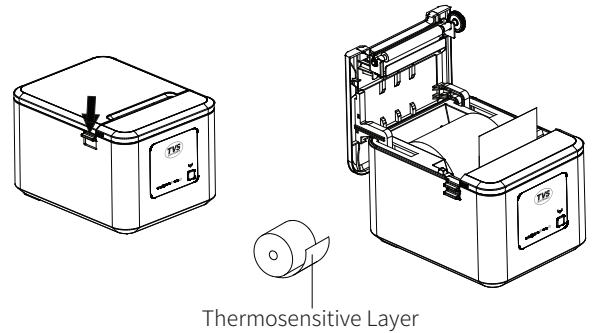

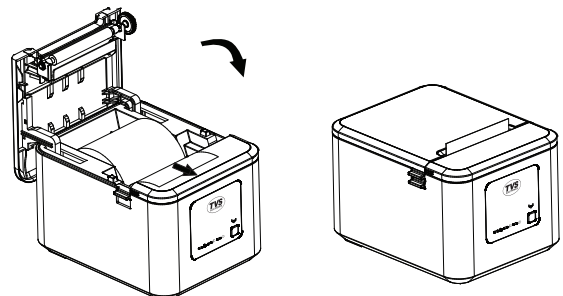

3. Pull out some paper, and close the printer cover.
4. Tear the extra paper.

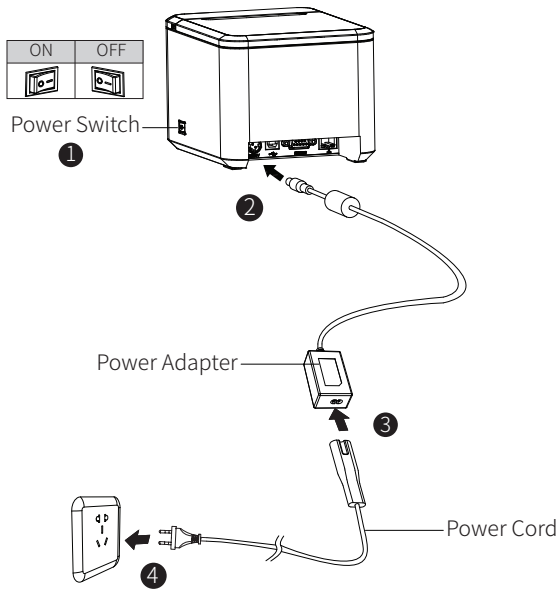

Power Supply

1. Make sure the printer is turned off.
2. Connect the power adapter to the printer.
3. Connect the power adapter to the power cord.
4. Plug the other side of the power cord into the socket outlet.



 Note: The power adapter and power cord vary by country or region.

CE DECLARATION OF CONFORMITY

Manufacturer certifies that the following designated product:

TVS-E RP 3230

Type of product:

Direct Thermal Line Printing

It is in conformity with the standards.

Test Standard Information

Under the Council Directive: (LVD) Directive 2014/35/EU relating to electrical equipment designed for use within Low Voltage Directive. EN 62368-1:2014+A11:2017

Under the Council Directive: (EMC) Directive 2014/30/EU relating to Electro Magnetic Compatibility.

EN 55032: 2015+AC:2016

EN 55035: 2017

EN 61000-3-2: 2014

EN 61000-3-3: 2013

We declare herewith that as a result of the manner in which the device designated below was designed, the type of construction and the devices which, as a result have been brought on to the general market comply with the relevant fundamental regulations of the CE Rules for Safety. And we declare herewith the above mentioned model is conformity with Directive 2014/30/EU and 2014/35/EU. In the event of any alteration which has not been approved by us being made to any device as designated above, this statement shall thereby be made invalid.

The declaration is sole responsibility of the manufacturer TVS-E.

Ethernet Setting

1. Connect the printer to router (or master device) through the network cable;
2. The default Ethernet mode is Static IP Mode with IP address "192.168.0.31";
3. Ethernet interface parameters can be set through POS utility or web (Master device and printer are under the same network segment, enter 192.168.0.31 in master device browser);
4. Please refer to User Manual for details.

FCC Warning

This device complies with part 15 of the FCC Rules. Operation is subject to the following two conditions: (1) this device may not cause harmful interference, and (2) this device must accept any interference received, including interference that may cause undesired operation.

Any changes or modifications not expressly approved by the party responsible for compliance could void the user's authority to operate the equipment.

NOTE: This equipment has been tested and found to comply with the limits for a Class A digital device, pursuant to part 15 of the FCC Rules. These limits are designed to provide reasonable protection against harmful interference when the equipment is operated in a commercial environment. This equipment generates, uses, and can radiate radio frequency energy and, if not installed and used in accordance with the instruction manual, may cause harmful interference to radio communications. Operation of this equipment in a residential area is likely to cause harmful interference in which case the user will be required to correct the interference at his own expense.

- Reorient or relocate the receiving antenna.
- Increase the separation between the equipment and receiver.
- Connect the equipment into an outlet on a circuit different from that to which the receiver is connected.
- Consult the dealer or an experienced radio/TV technician for help.

The device has been evaluated to meet general RF exposure requirement. The device can be used in portable exposure condition without restriction.

